

# STYLE *by* CHOICE

## *Lifestyle Range* *Product Catalogue*

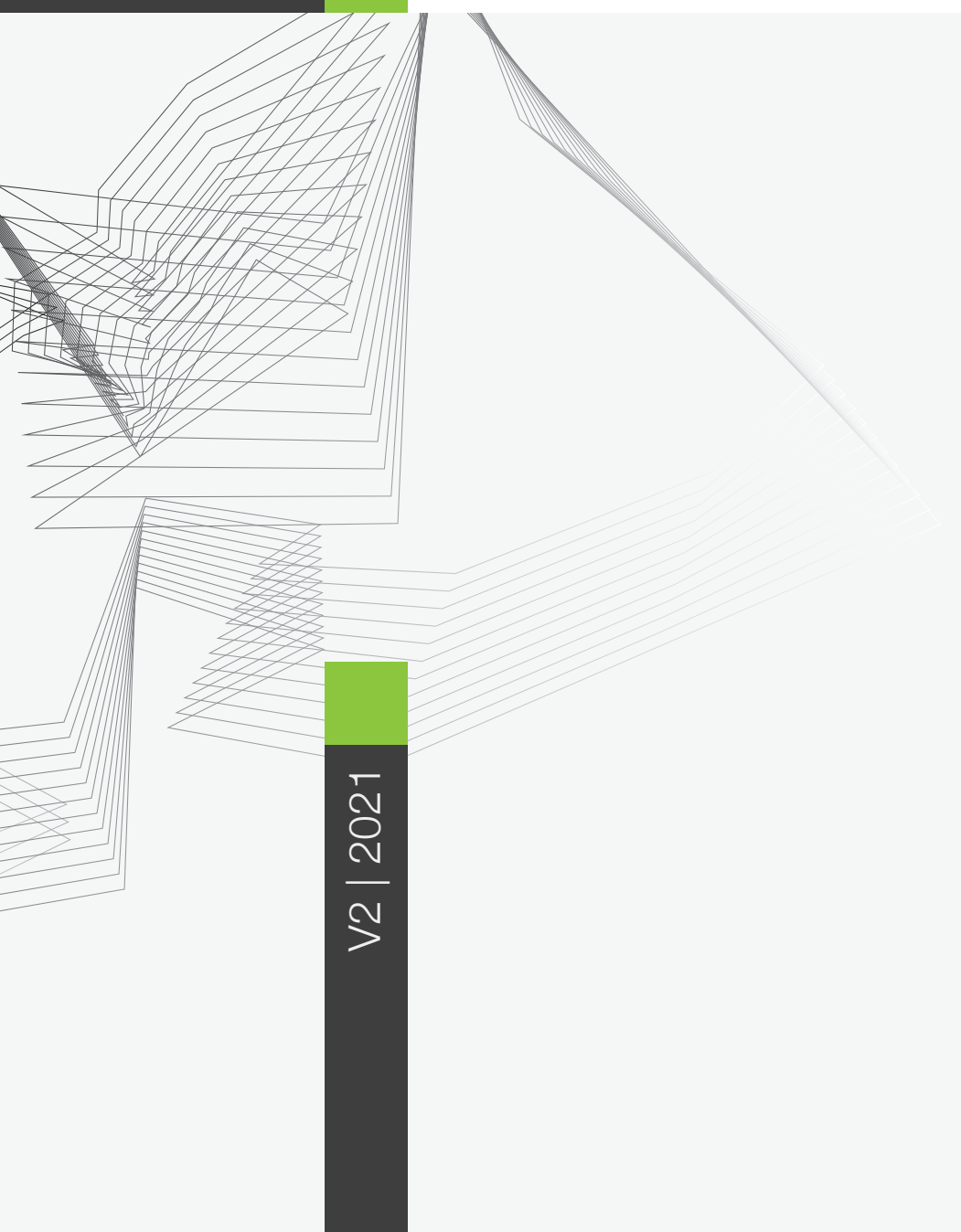

V2 | 2021

 **ANMAR** Group



---

# Contents

**OVERVIEW** .....3

**KITCHEN & BUTLER’S PANTRY** .....5

    Cabinet Library.....6

    Product Availability Guide (Matrix) ..... 18

**LAUNDRY** .....25

    Cabinet Library.....26

    Product Availability Guide (Matrix) .....32

**VANITY** .....35

    Cabinet Library.....36

    Product Availability Guide (Matrix) .....40

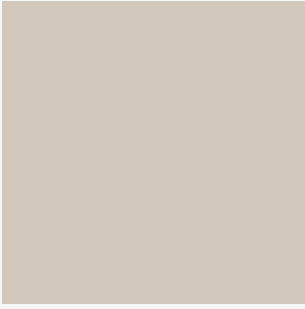

Copyright © 2021 Style by Choice | Anmar Group

Style by Choice Pty Ltd ACN 147 805 169

Anmar Group Pty Ltd ABN 55 129 579 406

14, Felstead Drive, Truganina VIC 3029

[stylebychoice.com.au](http://stylebychoice.com.au) | [anmargroup.com.au](http://anmargroup.com.au)



## **OVERVIEW**

With the application of over 35 years of experience, **Style by Choice** is a guide for the Australian building and joinery industry that has been formulated by the team at Anmar Group to aid designers and manufacturers alike.

**Lifestyle Range Product Catalogue** – The Lifestyle range of cabinets are flexible and modular, and based on the principles of the **Style by Choice Joinery Guide**. They form a versatile library of joinery for kitchens, laundries and vanities that are ready for use in design, allowing designers to achieve quicker results.

This document can be used for reference or in conjunction with the guide in the design and construction of kitchens and other joinery.

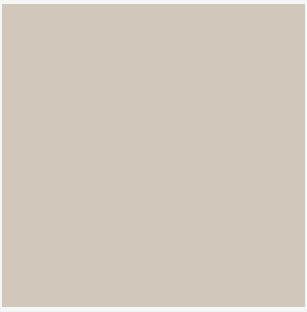

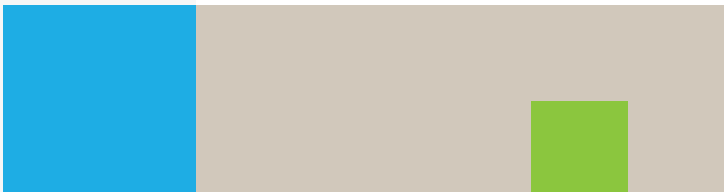

# ***KITCHEN & BUTLER'S PANTRY***

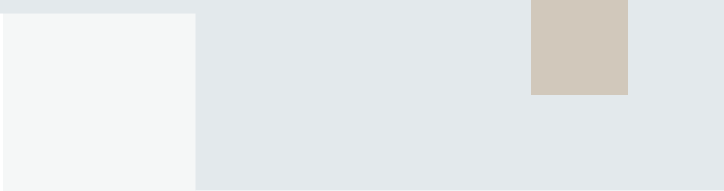

# Cabinet Library

## BASE DOOR

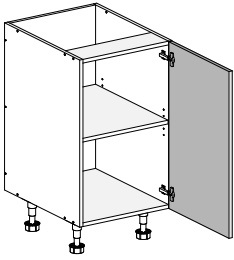

1 DOOR

H 722  
W 150 - 600  
D 340, 480, 580

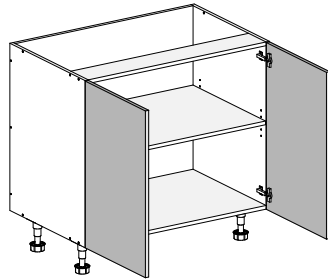

2 DOOR

H 722  
W 600 - 1200  
D 340, 480, 580

## BASE DRAWER & DOOR

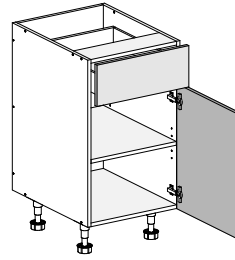

1 DRAWER, 1 DOOR

H 722  
W 300 - 600  
D 340, 480, 580

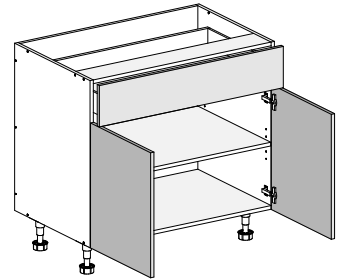

1 DRAWER, 2 DOOR

H 722  
W 600 - 1200  
D 340, 480, 580

## BASE DRAWER

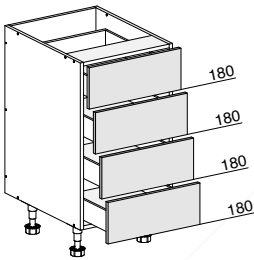

4 EQUAL DRAWER

H 722  
W 300 - 1200  
D 340, 480, 580

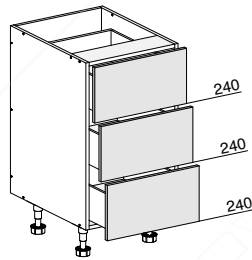

3 EQUAL DRAWER

H 722  
W 300 - 1200  
D 340, 480, 580

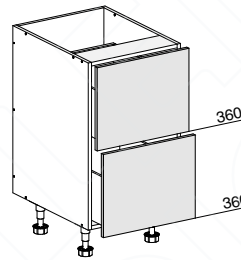

2 EQUAL DRAWER

H 722  
W 300 - 1200  
D 340, 480, 580

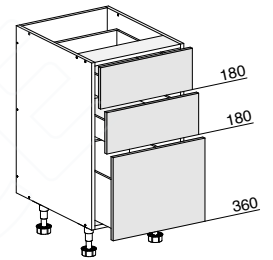

3 DRAWER (2 CUTLERY DRAWERS, 1 POT DRAWER)

H 722  
W 300 - 1200  
D 340, 480, 580

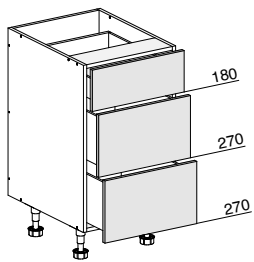

3 DRAWER (1 CUTLERY DRAWER, 2 POT DRAWERS)

H 722  
W 300 - 1200  
D 340, 480, 580

## INTERNAL DRAWER SIDE HEIGHTS

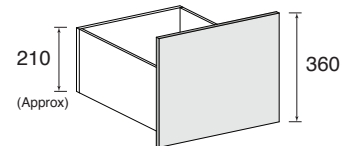
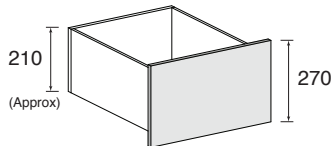
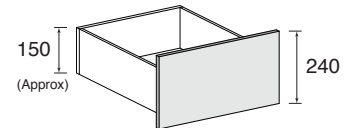
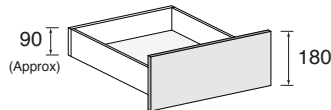

**NOTE:** Internal Drawer Side Heights are approximate and may vary depending on *Hardware Brand* specified and *Handle Option* selected.

### Design Note:

Base cabinet heights do not include kickboard.



## BASE CORNER

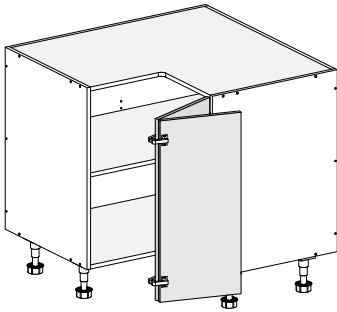

### 2 DOOR

H 722  
W [See Matrix](#)  
D 340x340, 480x480, 580x580

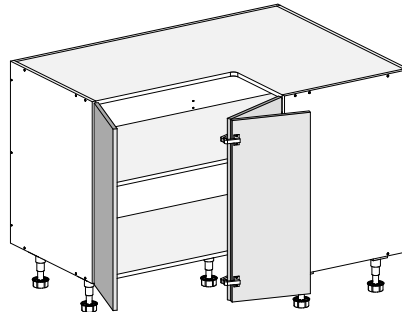

### 3 DOOR

H 722  
W [See Matrix](#)  
D 580x580

## BASE RETURN

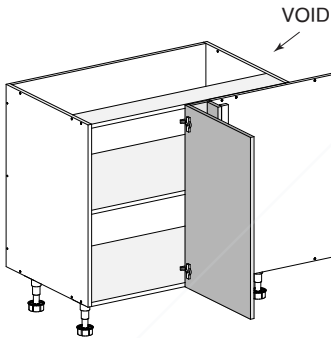

### 1 DOOR

H 722  
W [See Matrix](#)  
D 340, 480, 580

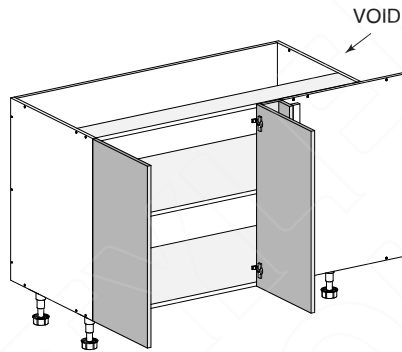

### 2 DOOR

H 722  
W [See Matrix](#)  
D 340, 480, 580

## OVERHEAD DOOR

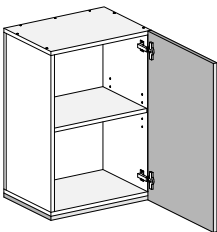

### 1 DOOR

H 550, 670, 790\*  
W 150 - 600  
D 340, 480  
\*2 Shelves

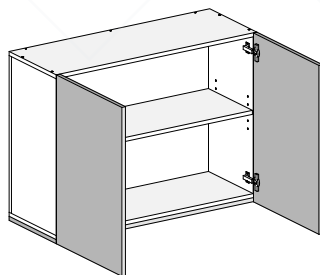

### 2 DOOR

H 550, 670, 790\*  
W 600 - 1200  
D 340, 480  
\*2 Shelves

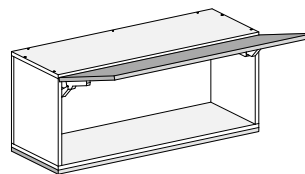

### LIFT UP DOOR

H 275, 335, 395  
W 300 - 1200  
D 340, 480

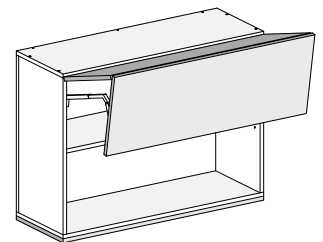

### BI FOLD LIFT UP DOOR

H 550, 670, 790\*  
W 300 - 1200  
D 340, 480  
\*1 Shelf

NOTE: Shelves cannot be full depth due to closing mechanism.

### Design Note:

See Matrix on page 20 for exact available sizes.

## Cabinet Library

### OVERHEAD CORNER

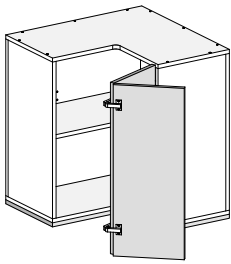

#### 2 DOOR

H 550, 670, 790  
 W [See Matrix](#)  
 D 340x340, 480x480

### OVERHEAD RETURN

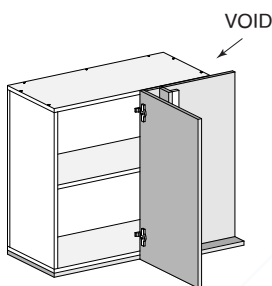

#### 1 DOOR

H 550, 670, 790  
 W [See Matrix](#)  
 D 340, 480

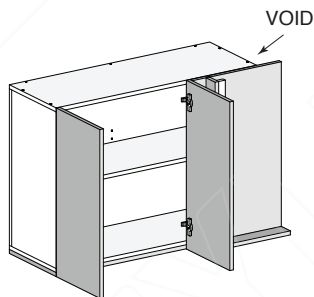

#### 2 DOOR

H 550, 670, 790  
 W [See Matrix](#)  
 D 340, 480

### OVERHEAD FRIDGE

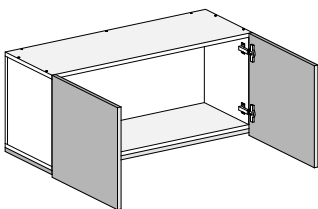

#### 2 DOOR

H 275, 395, 515\*  
 W 800 - 1200  
 D 340  
 \*1 Shelf

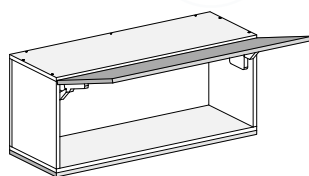

#### LIFT UP DOOR

H 275, 395  
 W 800 - 1200  
 D 340

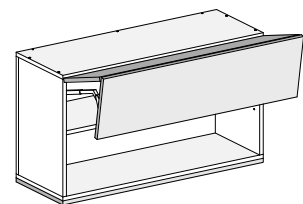

#### BI FOLD LIFT UP DOOR

H 515\*  
 W 800 - 1200  
 D 340  
 \*1 Shelf

NOTE: Shelf cannot be full depth due to closing mechanism.

#### Design Note:

Fridge overhead cabinet heights suit fridge appliance clearance heights of 1880mm only.

## TALL PANTRY

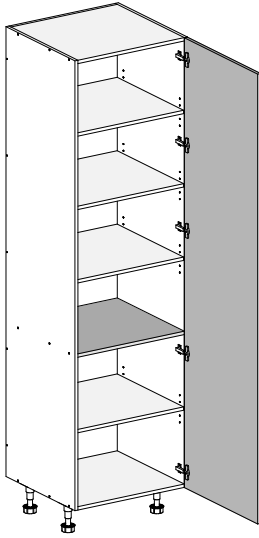

### 1 DOOR

H 2155, 2275, 2395  
 W 300 - 600  
 D 340, 480, 580  
 ■ Fixed shelf

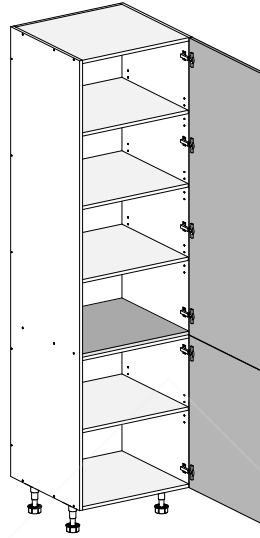

### 1 DOOR - SPLIT

H 2155, 2275, 2395  
 W 300 - 600  
 D 340, 480, 580  
 ■ Fixed shelf

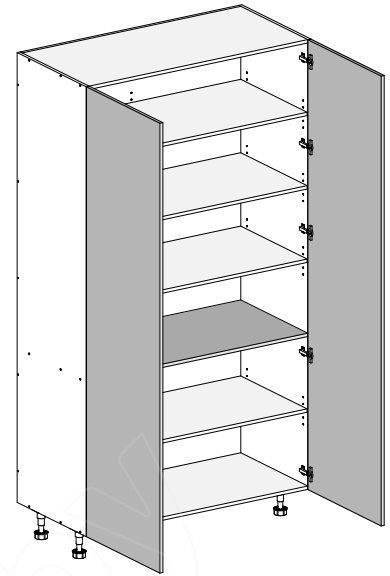

### 2 DOOR

H 2155, 2275, 2395  
 W 600 - 1200  
 D 340, 480, 580  
 ■ Fixed shelf

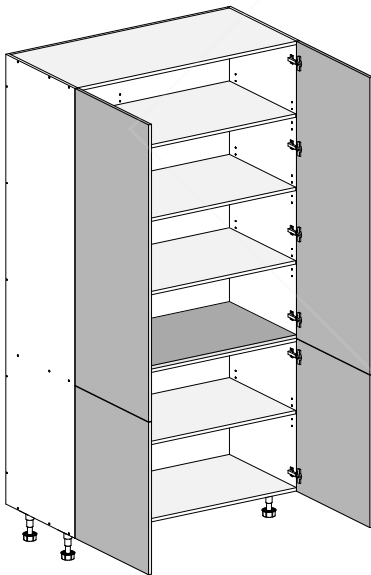

### 2 DOOR - SPLIT

H 2155, 2275, 2395  
 W 600 - 1200  
 D 340, 480, 580  
 ■ Fixed shelf

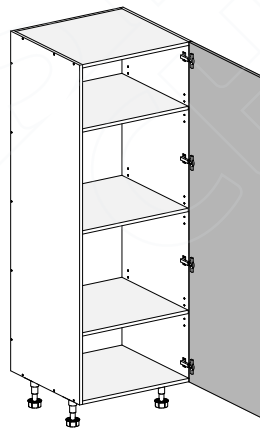

### MINI 1 DOOR

H 1605  
 W 300 - 600  
 D 340, 480, 580

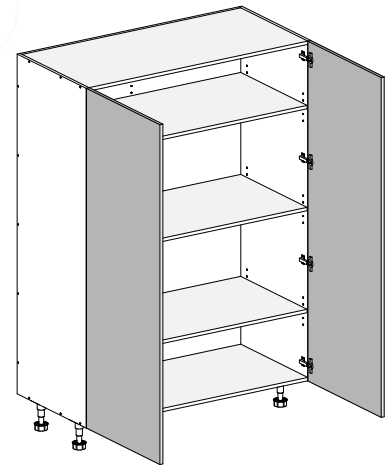

### MINI 2 DOOR

H 1605  
 W 600 - 1200  
 D 340, 480, 580

#### Design Note:

Tall cabinets are available with or without rear voids.

#### Design Note:

All tall cabinet heights include kickboard.

# Cabinet Library

## TALL PANTRY RETURN

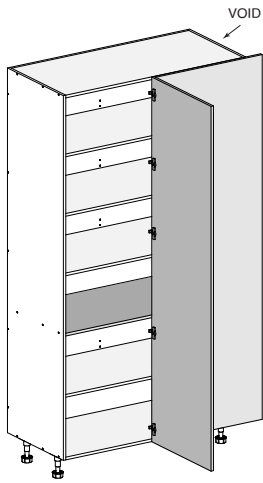

1 DOOR

H 2155, 2275, 2395  
 W [See Matrix](#)  
 D 340, 480, 580  
 ■ Fixed shelf

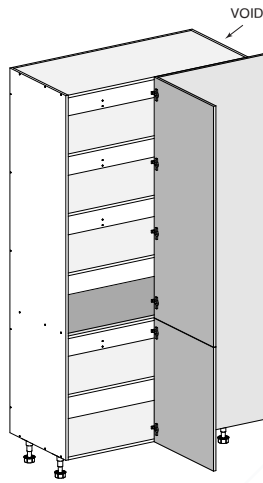

1 DOOR - SPLIT

H 2155, 2275, 2395  
 W [See Matrix](#)  
 D 340, 480, 580  
 ■ Fixed shelf

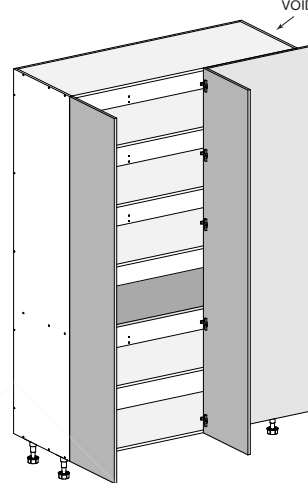

2 DOOR

H 2155, 2275, 2395  
 W [See Matrix](#)  
 D 340, 480, 580  
 ■ Fixed shelf

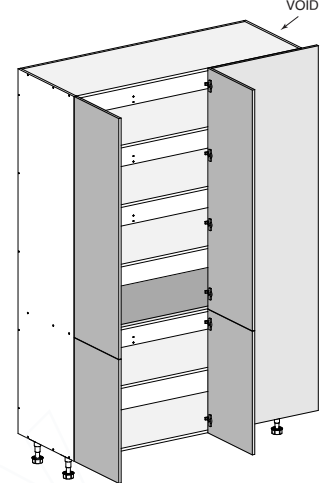

2 DOOR - SPLIT

H 2155, 2275, 2395  
 W [See Matrix](#)  
 D 340, 480, 580  
 ■ Fixed shelf

## TALL PANTRY CORNER

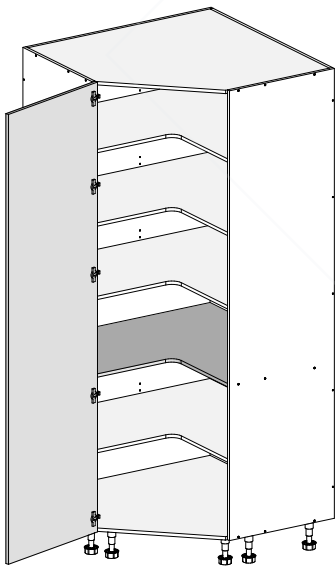

1 DOOR - ANGLE

H 2155, 2275, 2395  
 W 1029x1029  
 D 580  
 ■ Fixed shelf

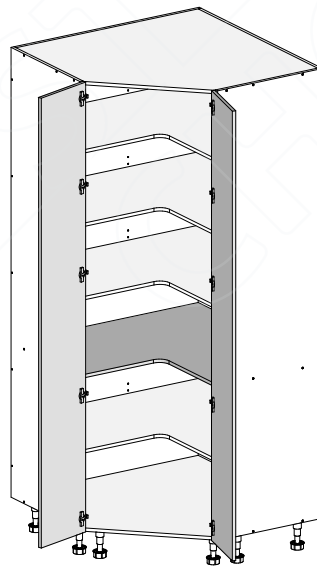

2 DOOR - ANGLE

H 2155, 2275, 2395  
 W 1029x1029  
 D 580  
 ■ Fixed shelf

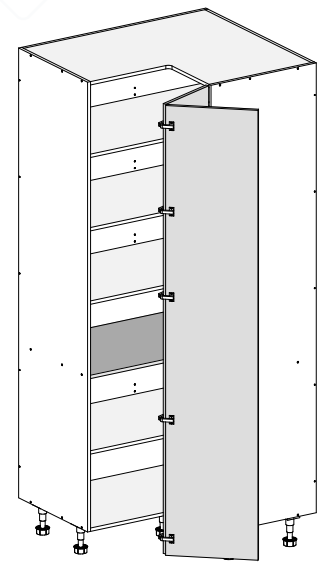

2 DOOR - L SHAPE

H 2155, 2275, 2395  
 W [See Matrix](#)  
 D 340, 480, 580  
 ■ Fixed shelf

**Design Note:**

All tall cabinet heights include kickboard.

## BENCHTOP TALL APPLIANCE

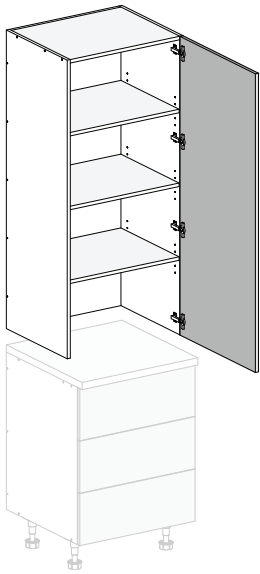

1 DOOR

H 1250, 1370, 1490  
W 300 - 600  
D 340, 480

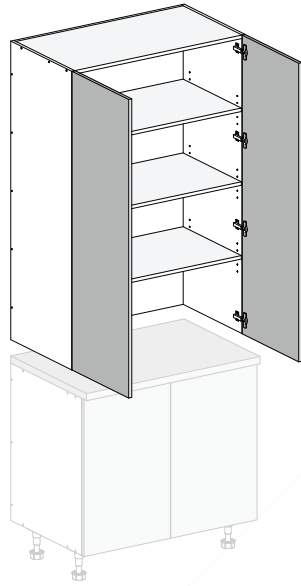

2 DOOR

H 1250, 1370, 1490  
W 600 - 1200  
D 340, 480

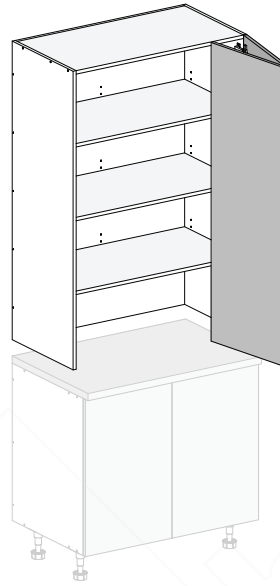

SINGLE BI FOLD DOOR

H 1250, 1370, 1490  
W 600 - 1200  
D 340, 480

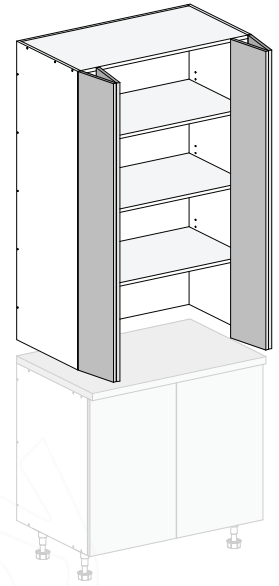

DOUBLE BI FOLD DOOR

H 1250, 1370, 1490  
W 900 - 1400  
D 340, 480

## BENCHTOP MINI APPLIANCE

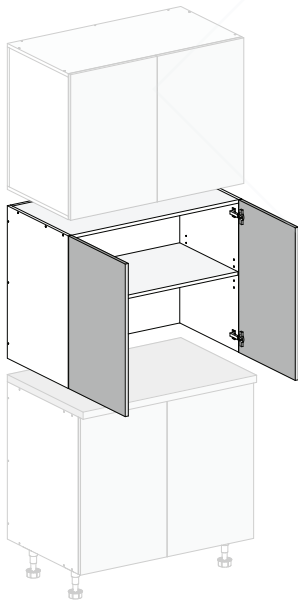

2 DOOR

H 700  
W 600 - 1200  
D 340, 480

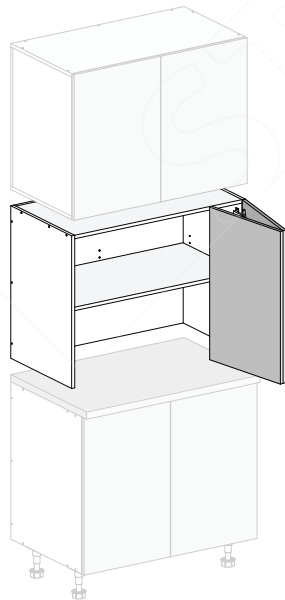

SINGLE BI FOLD DOOR

H 700  
W 600 - 1200  
D 340, 480

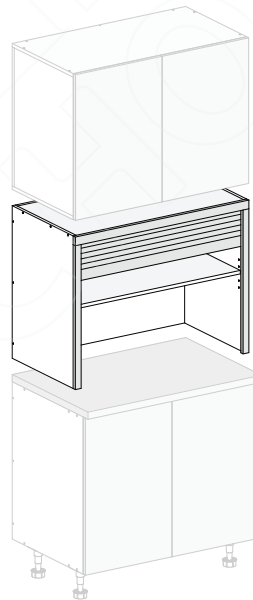

ROLLER DOOR

H 700  
W 600 - 1200  
D 340, 480

### Design Note:

Appliance cabinets are meant to be placed on benchtops, therefore they have no bottoms.

# Cabinet Library

## BASE UNDERBENCH APPLIANCE

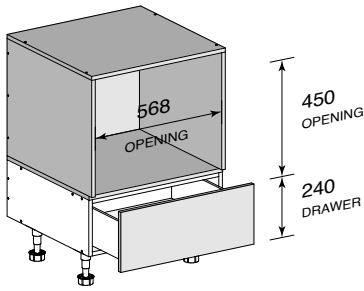

**UB MICROWAVE CABINET (Space Only) with 240 Drawer**

H 722 (240 Drawer)  
W 600  
D 580

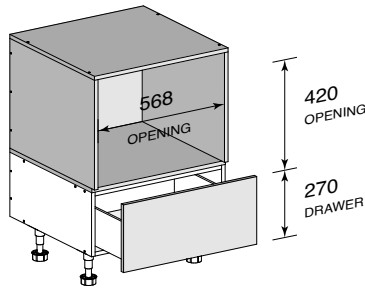

**UB MICROWAVE CABINET (Space Only) with 270 Drawer**

H 722 (270 Drawer)  
W 600  
D 580

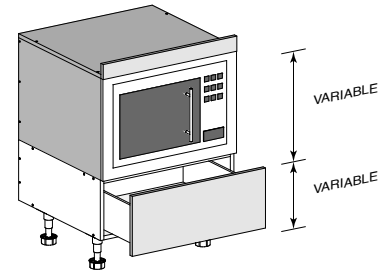

**UB MICROWAVE (Intergrated) with Drawer**

H 722  
W 600, 632\*  
D 580

\*only applicable for some brands

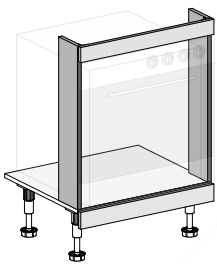

**UB OVEN 600 Wide**

H 722  
W 600  
D 580

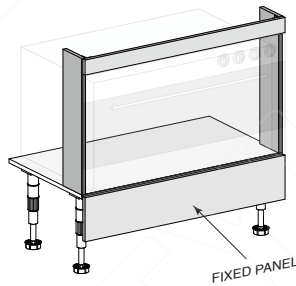

**UB OVEN 900 Wide**

H 722  
W 900  
D 580

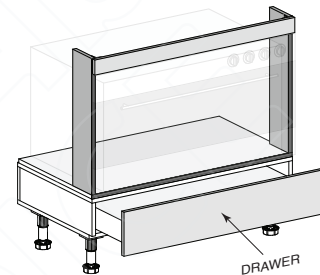

**UB OVEN 900 Wide with Drawer**

H 722  
W 900  
D 580

## OVERHEAD APPLIANCE

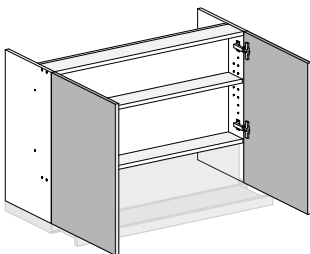

**SLIDE-OUT RANGEHOOD**

H 550, 670, 790  
W 600, 900  
D 340, 480

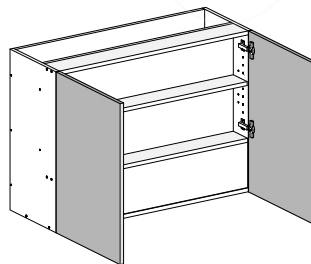

**UNDERMOUNT RANGEHOOD**

H 550, 670, 790  
W 600, 900  
D 340, 480

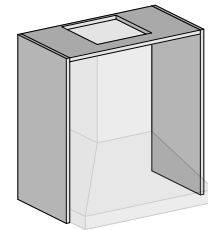

**CANOPY RANGEHOOD FLYOVER (With or Without Back)**

H 550, 670, 790  
W Variable  
D 340, 480

### Design Note:

For some rangehood models fixed panels maybe required instead of working doors.

## BASE OPEN SHELF

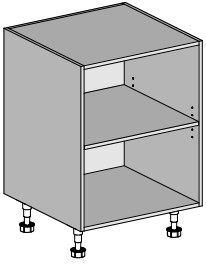

### SHELF UNIT

H 722  
W 150 - 1000  
D 340, 480, 580

#### Features

- Adjustable shelf

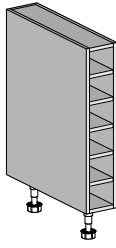

### WINE RACK

H 722  
W 150, 250, 400  
D 340, 480, 580

#### Features

- Fixed shelves

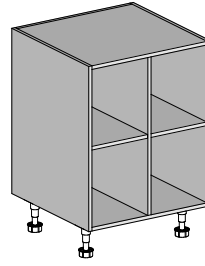

### CUBE

H 722  
W 600 - 1200  
D 340, 480, 580

#### Features

- Fixed shelves

#### Design Note:

Base cabinet heights do not include kickboard.

## OVERHEAD OPEN SHELF

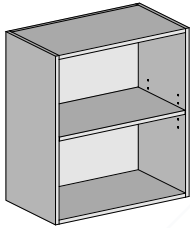

### SHELF UNIT

H 550, 670, 790\*  
W 300 - 1000  
D 340, 480  
\*2 Shelves

#### Features

- Adjustable shelf

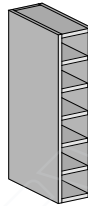

### WINE RACK

H 550, 670, 790  
W 150, 250, 400  
D 340, 480

#### Features

- Fixed shelves

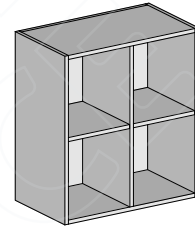

### CUBE

H 550, 670, 790  
W 600 - 1200  
D 340, 480

#### Features

- Fixed shelves

## OVERHEAD FRIDGE OPEN SHELF

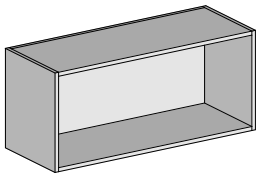

### SHELF UNIT

H 275, 395, 515\*  
W 800 - 1200  
D 340  
\*1 Shelf

#### Features

- Adjustable shelf

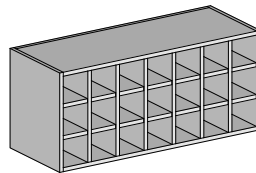

### WINE RACK

H 275, 395, 515  
W 800 - 1200  
D 340

#### Features

- Fixed shelves

## Cabinet Library

### TALL OPEN SHELF

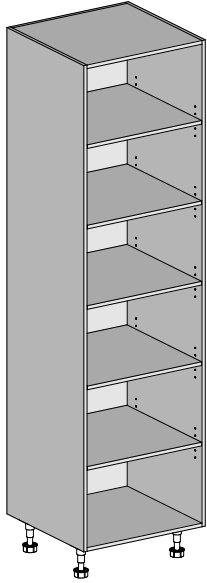

#### SHELF UNIT

H 1605, 2155, 2275, 2395

W 300 - 1000

D 340, 480, 580

#### Features

- Adjustable shelves

#### **Design Note:**

All tall cabinet heights include kickboard.



## FLOATING SHELVING

### MELAMINE WALL SHELF (Open Under)

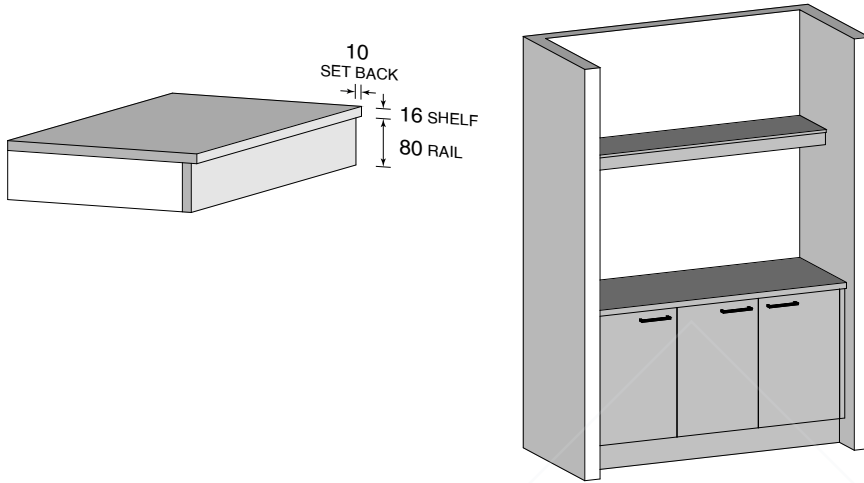

**FIXED TO WALL (Back & Both Ends)**

- H** 80mm Front Rail  
(Overall height 96mm including 16mm shelf)
- W** 1500max - No Support Panel
- D** 150 - 600

**NOTE:** Shelf must be fixed to wall on ends. Divisional support panel required when span exceeds 1500mm.

### LAMINATED WALL SHELF (Solid Bottom)

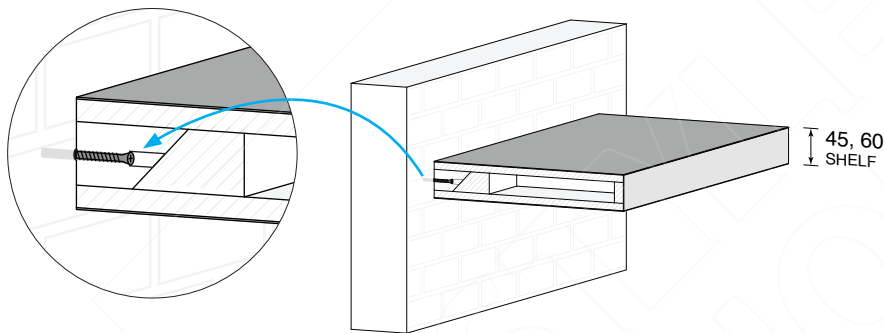

**Design Note:**

Noggings in walls are preferred for installation of floating shelves.

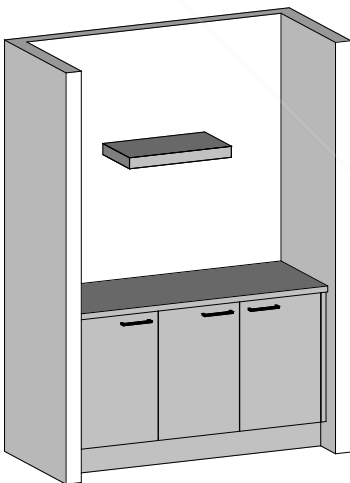

**FIXED TO WALL (Back Only)**

- H** 45, 60
- W** 1200 - 2400
- D** 150 - 340

**WEIGHT ALLOWANCE**

- W** 1200 - 1800: 30 kg
- W** 1801 - 2400: 35 kg

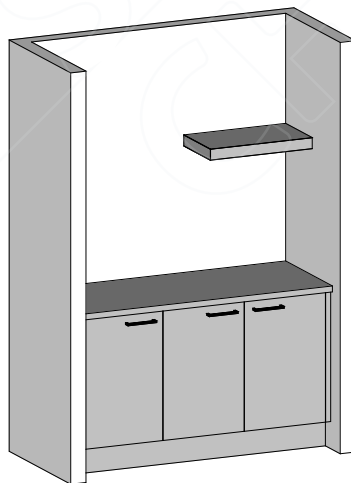

**FIXED TO WALL (Back & One End)**

- H** 45, 60
- W** 700 - 3600
- D** 150 - 340

**WEIGHT ALLOWANCE**

- W** 700 - 1800: 30 kg
- W** 1801 - 3600: 35 kg

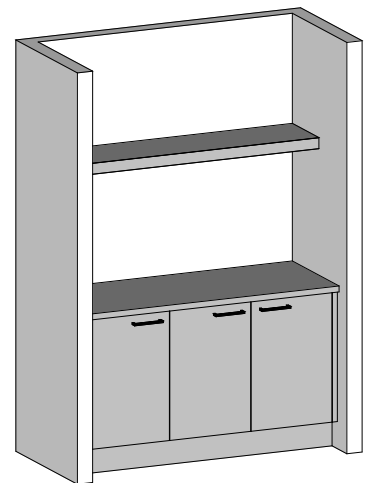

**FIXED TO WALL (Back & Both Ends)**

- H** 45, 60
- W** 700 - 3600
- D** 150 - 340

**WEIGHT ALLOWANCE**

- W** 700 - 3600: 35 kg

# Cabinet Library

## WALL OVEN TOWERS

The wall oven tower options shown are designed around various appliance combinations that easily align with base cabinets from the Lifestyle range.

The designs are mainly dictated by the height of the appliance combinations and the base cabinet selection. Once these heights are known, an overhead cabinet of choice can be placed to complete the tower.

### SINGLE WALL OVEN (600) + MICROWAVE / COFFEE MACHINE / STEAM OVEN

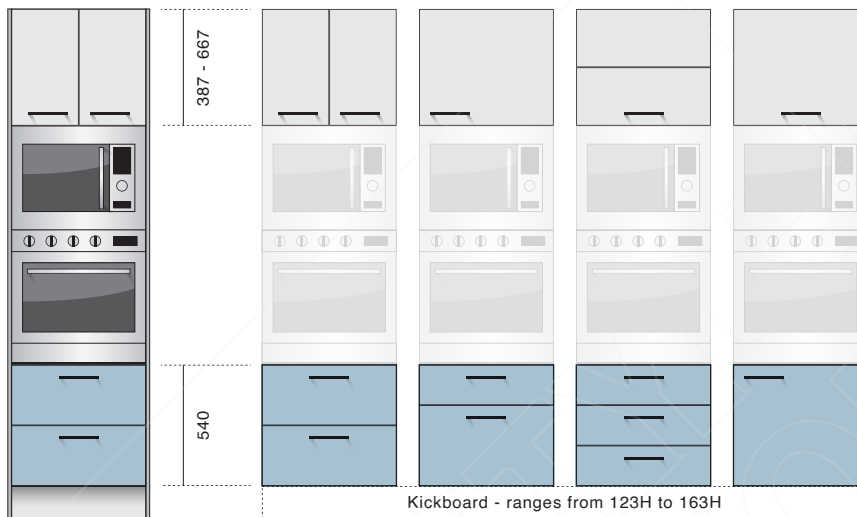

### SINGLE WALL OVEN (600) + MICROWAVE / COFFEE MACHINE / STEAM OVEN

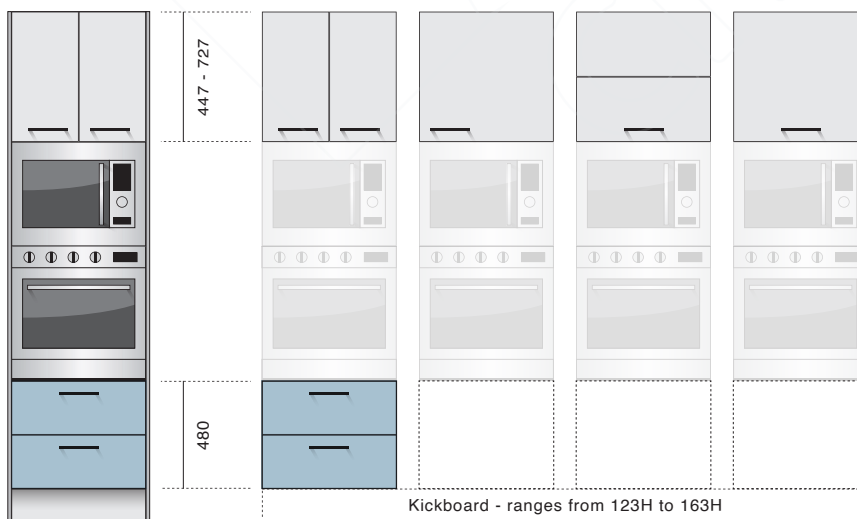

**SINGLE WALL OVEN (600)**

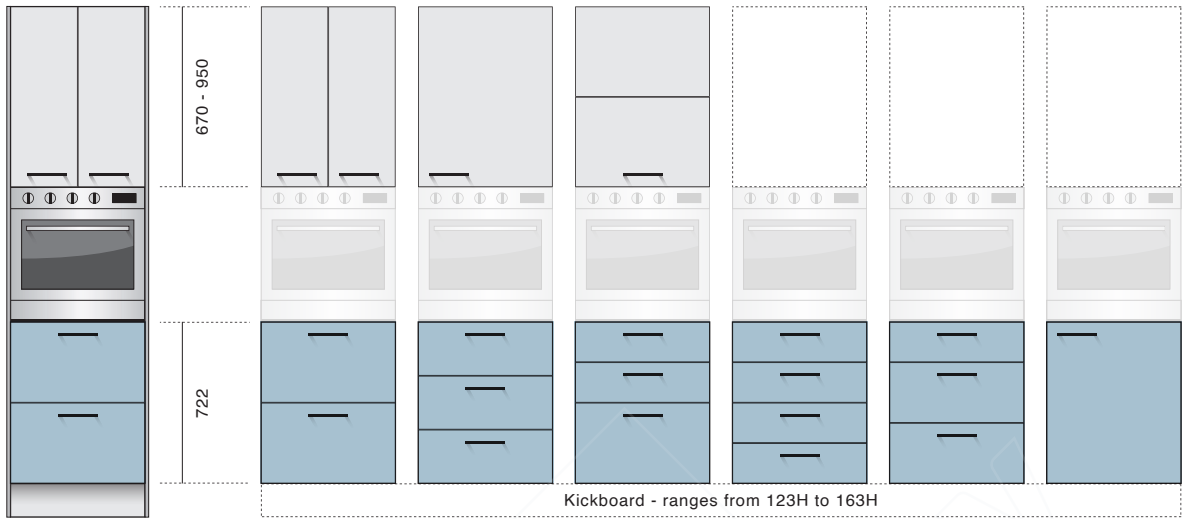

**DOUBLE WALL OVEN (600)**

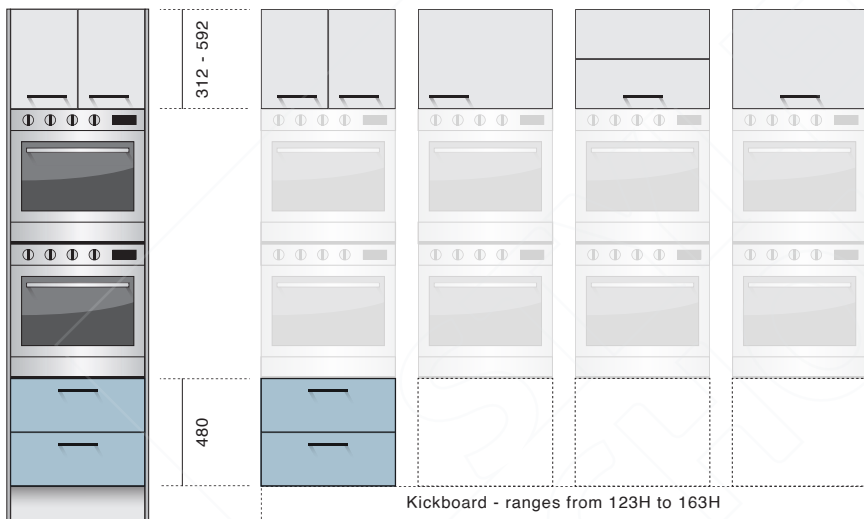

**DOUBLE WALL OVEN (600)**







# Product Availability Guide (Matrix)

	DESCRIPTION	CABINET HEIGHTS (excluding kickboard height except TALL CABINETS which include a kickboard therefore is the overall cabinet height)													150								
		CABINET DEPTHS (including door)			275	335	395	515	550	635	670	700	722	790		1250	1370	1490	1605	2155	2275	2395	
		340	480	580																			
<b>OVERHEAD</b>	<b>OVERHEAD DOOR</b>																						
	OVERHEAD DOOR - 1 Door	•	•		•	•	•	•	•	•				•								•	
	OVERHEAD DOOR - 2 Door	•	•		•	•	•	•	•	•				•									
	OVERHEAD DOOR - Lift Up Door	•	•		•	•																	
	OVERHEAD DOOR - Bi Fold Lift Up Door	•	•					•	•	•	•			•									
	<b>OVERHEAD CORNER</b>																						
	OVERHEAD CORNER - 2 Door 340x340	•								•	•			•									
	OVERHEAD CORNER - 2 Door 480x480		•								•	•			•								
	<b>OVERHEAD RETURN</b>																						
	OVERHEAD RETURN - 1 Door — 340 Deep (410 panel)	•								•	•			•									
	OVERHEAD RETURN - 2 Door — 340 Deep (410 panel)	•									•	•			•								
	OVERHEAD RETURN - 1 Door — 480 Deep (550 panel)		•								•	•			•								
	OVERHEAD RETURN - 2 Door — 480 Deep (550 panel)		•								•	•			•								
	<b>OVERHEAD FRIDGE</b>																						
	OVERHEAD FRIDGE - 2 Door	•								•	•	•											
	OVERHEAD FRIDGE - Lift Up Door	•								•	•												
	OVERHEAD FRIDGE - Bi Fold Lift Up Door	•									•												
	<b>OVERHEAD APPLIANCE</b>																						
	OVERHEAD APPLIANCE - Slideout Rangehood	•	•								•	•			•								
	OVERHEAD APPLIANCE - Undermount Rangehood	•	•								•	•			•								
	OVERHEAD APPLIANCE - Canopy Rangehood Flyover (With or Without Back)	•	•								•	•			•								
	<b>BENCHTOP TALL APPLIANCE</b>																						
	BENCHTOP APPLIANCE - 1 Door	•	•														•	•	•				
	BENCHTOP APPLIANCE - 2 Door	•	•														•	•	•				
	BENCHTOP APPLIANCE - Single Bi Fold Door	•	•														•	•	•				
	BENCHTOP APPLIANCE - Double Bi Fold Door	•	•														•	•	•				
	<b>BENCHTOP MINI APPLIANCE</b>																						
	BENCHTOP APPLIANCE - 2 Door	•	•										•										
	BENCHTOP APPLIANCE - Single Bi Fold Door	•	•										•										
	BENCHTOP APPLIANCE - Roller Door	•	•										•										
	<b>OVERHEAD OPEN SHELF</b>																						
	OVERHEAD OPEN SHELF - Unit	•	•								•	•	•	•		•							•
	OVERHEAD OPEN SHELF - Cube	•	•									•	•			•							
	OVERHEAD OPEN SHELF - Wine Rack (HxW capacity/bottles)	•	•									•	•			•							•
	<b>OVERHEAD FRIDGE OPEN SHELF</b>																						
	OVERHEAD FRIDGE OPEN SHELF - Unit	•									•	•	•										
	OVERHEAD FRIDGE OPEN SHELF - Wine Rack (HxW capacity/bottles)	•									•	•	•										
	<b>OVERHEAD FLOATING SHELVING</b>																						
	MELAMINE WALL SHELF (Open Under) 16mm with 80mm high front rail <sup>1</sup>																						
	LAMINATED WALL SHELF (Solid Bottom) 45mm and 60mm thick <sup>1</sup>																						

<sup>1</sup> Please refer to KITCHEN & BUTLER'S PANTRY Catalogue on page 15 for details.









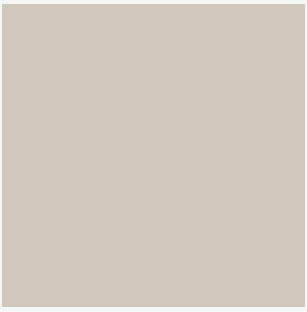



# LAUNDRY

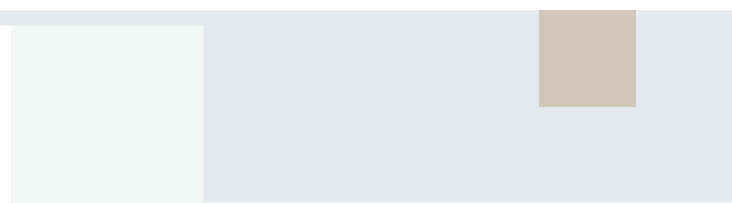

## Cabinet Library

### BASE DOOR

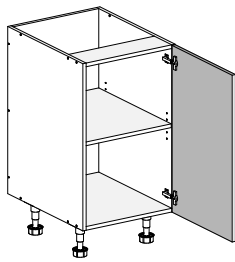

#### 1 DOOR

H 722  
W 300 - 600  
D 580

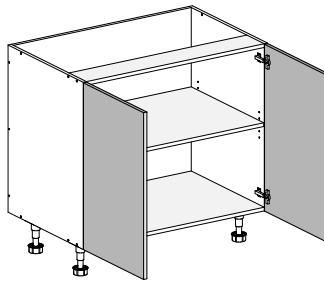

#### 2 DOOR

H 722  
W 600 - 1200  
D 580

### BASE RETURN

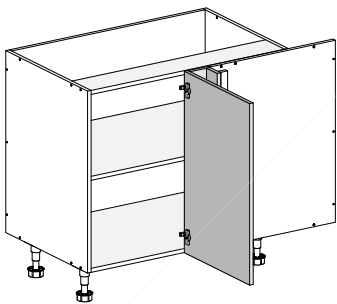

#### 1 DOOR

H 722  
W [See Matrix](#)  
D 580

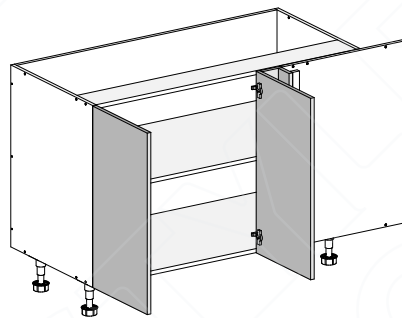

#### 2 DOOR

H 722  
W [See Matrix](#)  
D 580

**Design Note:**

Base cabinet heights do not include kickboard.

**Design Note:**

Our Laundry range of cabinets suit most laundry designs and layouts. Refer to our Kitchen Product Library for a wider selection of cabinets.

## OVERHEAD DOOR

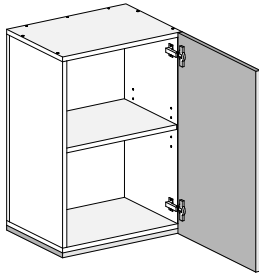

### 1 DOOR

H 550, 670, 790\*  
 W 300 - 600  
 D 340, 480  
 \*2 Shelves

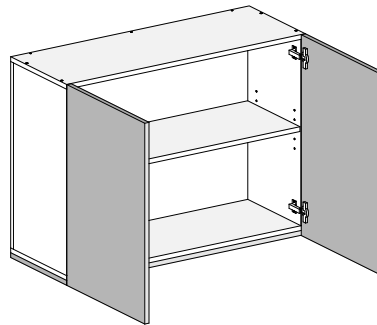

### 2 DOOR

H 550, 670, 790\*  
 W 600 - 1200  
 D 340, 480  
 \*2 Shelves

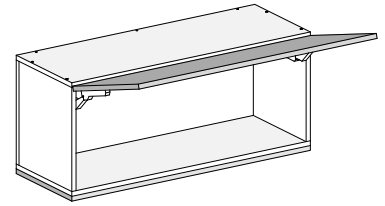

### LIFT UP DOOR

H 275, 335, 395  
 W 300 - 1200  
 D 340, 480

#### Features

- Single row floating or stackable

## OVERHEAD RETURN

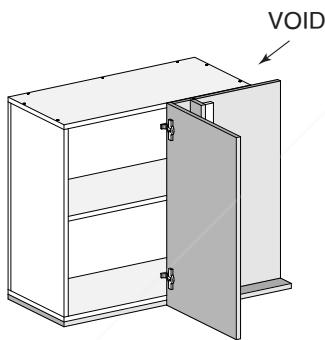

### 1 DOOR

H 550, 670, 790\*  
 W [See Matrix](#)  
 D 340, 480  
 \*2 Shelves

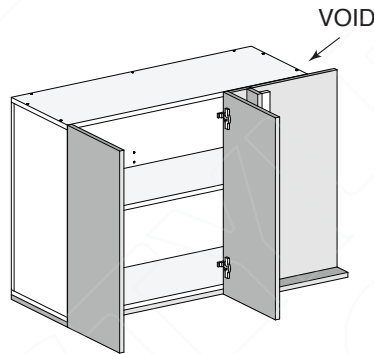

### 2 DOOR

H 550, 670, 790\*  
 W [See Matrix](#)  
 D 340, 480  
 \*2 Shelves

## OVERHEAD DOOR WITH HANGING RAIL UNDER

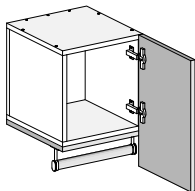

### 1 DOOR

H 275, 335, 395  
 W 300 - 600  
 D 340, 480

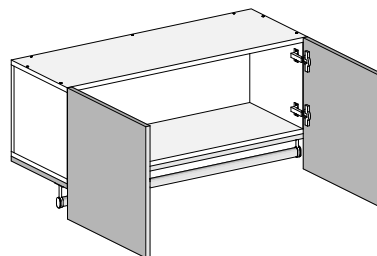

### 2 DOOR

H 275, 335, 395  
 W 600 - 1200  
 D 340, 480

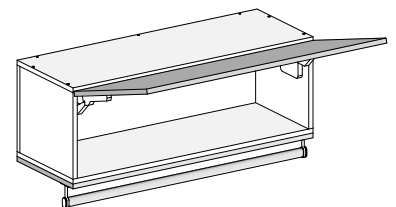

### LIFT UP DOOR

H 275, 335, 395  
 W 300 - 1200  
 D 340, 480

#### Design Note:

Overhead cabinets with hanging rails have drop down doors that offer a 100mm area that covers the rail.

# Cabinet Library

## TALL DOOR

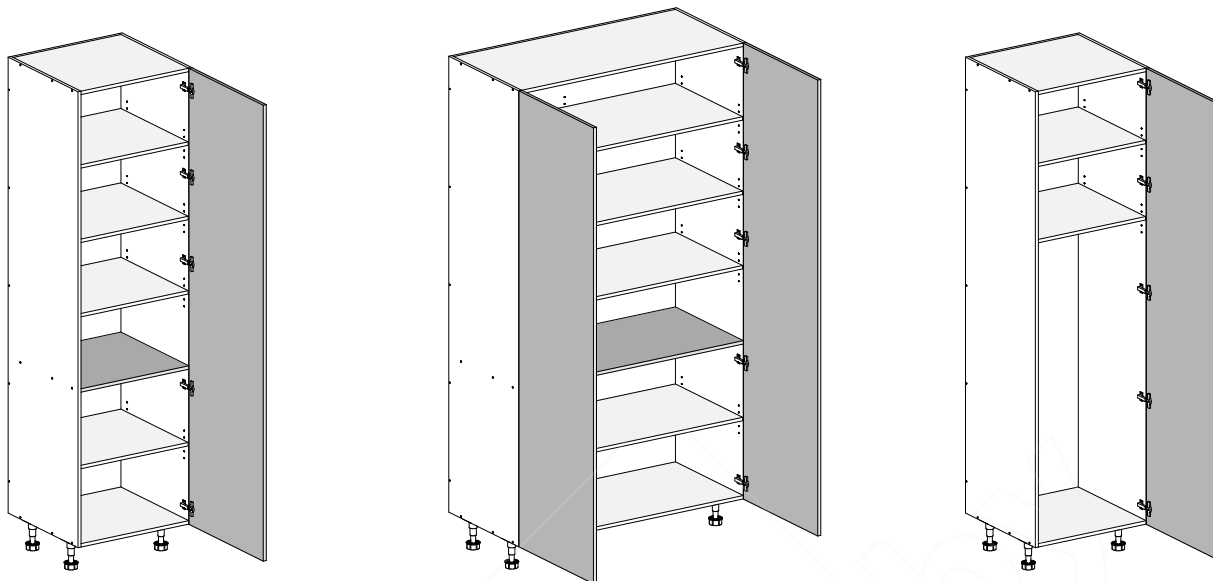

### LINEN 1 DOOR

H 2155, 2275, 2395  
 W 300 - 600  
 D 580  
 ■ Fixed shelf

### LINEN 2 DOOR

H 2155, 2275, 2395  
 W 600 - 1200  
 D 580  
 ■ Fixed shelf

### BROOM 1 DOOR

H 2155, 2275, 2395  
 W 300 - 600  
 D 580

## FLOATING SHELVING

### MELAMINE WALL SHELF (Open Under)

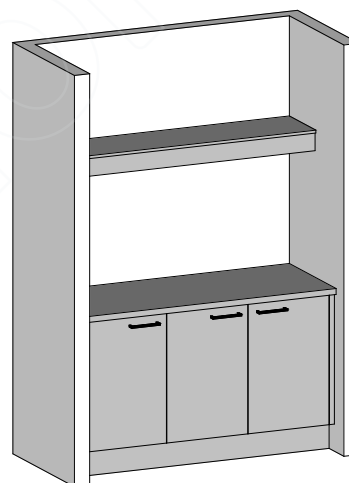
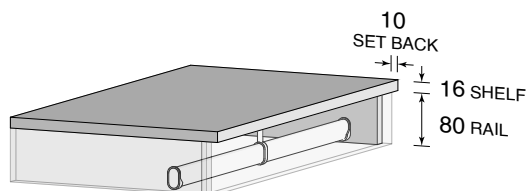
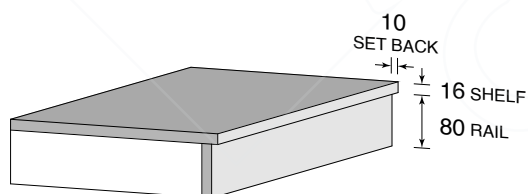

### FIXED TO WALL (Back & Both Ends)

H 80mm Front Rail  
 (Overall height 96mm including 16mm shelf)  
 W 1500max  
 D 150 - 600

NOTE: Shelf must be fixed to wall on ends. Divisional support panel required when span exceeds 1500mm.

### Design Note:

All tall cabinet heights include kickboard.

## BASE OPEN SHELF

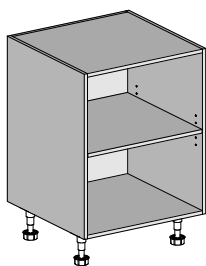

### SHELF UNIT

H 722  
W 300 - 1000  
D 580

#### Features

- Adjustable shelves

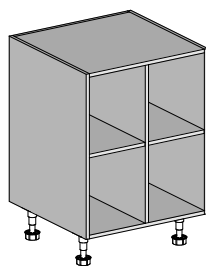

### CUBE

H 722  
W 600 - 1200  
D 580

#### Features

- Fixed shelves

#### **Design Note:**

Base cabinet heights do not include kickboard.

## OVERHEAD OPEN SHELF

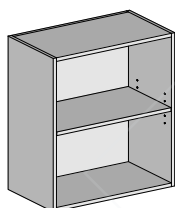

### SHELF UNIT

H 550, 670, 790\*  
W 300 - 1000  
D 340, 480  
\*2 Shelves

#### Features

- Adjustable shelf

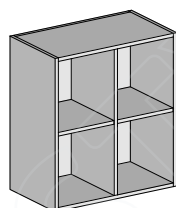

### CUBE

H 550, 670, 790  
W 600 - 1200  
D 340, 480

#### Features

- Fixed shelves

## TALL OPEN SHELF

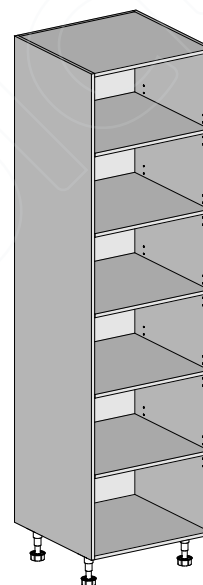

### SHELF UNIT

H 2155, 2275, 2395  
W 300 - 1000  
D 580

#### Features

- Adjustable shelves

#### **Design Note:**

All tall cabinet heights include kickboard.

# Cabinet Library

## TALL APPLIANCE TOWERS

### WASHER OR DRYER SPACE

(Tower with Tall Panels, Base Cabinets & Overhead Cabinets)

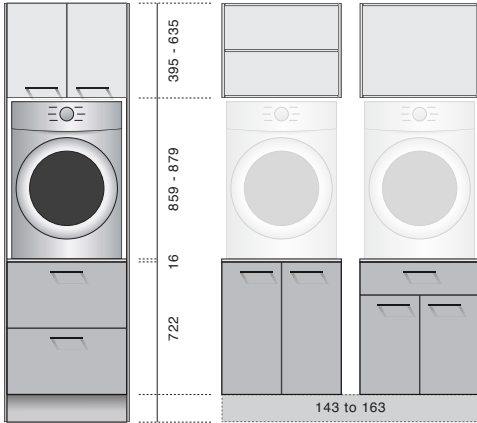

W: 682 (650 internal)  
D: 702

	KICKER HEIGHT	WASHER/ DRYER SPACE HEIGHT	OVERHEAD HEIGHT	OVERHEAD STORAGE OPTIONS			BASE STORAGE OPTIONS		
				OPEN BOX	OPEN SHELF	2 DOOR OVERHEAD	2 DRAWER	2 DOOR	DRAWER/ DOOR
2155	163	859	395	•	•	•	•	•	•
	150	872							
	147	875							
	143	879							
2275	163	859	515	•	•	•	•	•	•
	150	872							
	147	875							
	143	879							
2395	163	859	635	•	•	•	•	•	•
	150	872							
	147	875							
	143	879							

### WASHER & DRYER STACK ON FLOOR

(Tower with Tall Panels & Overhead Cabinets – NO BASE)

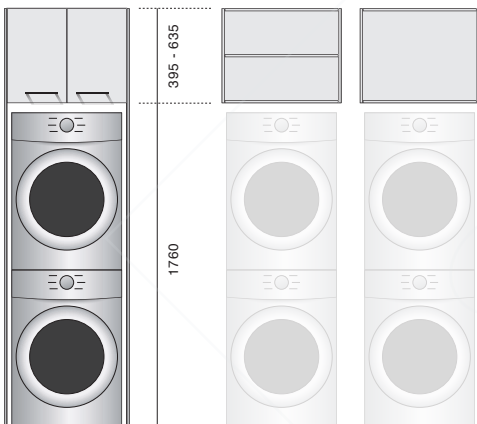

W: 682 (650 internal)  
D: 702

	KICKER HEIGHT	WASHER/ DRYER SPACE HEIGHT	OVERHEAD HEIGHT	OVERHEAD STORAGE OPTIONS		
				OPEN BOX	OPEN SHELF	2 DOOR OVERHEAD
2155	N/A	1760	395	•	•	•
2275	N/A	1760	515	•	•	•
2395	N/A	1760	635	•	•	•

### WASHER & DRYER STACK IN CABINET

(Tower with Kicker Base, Tall Panels & Overhead Cabinets)

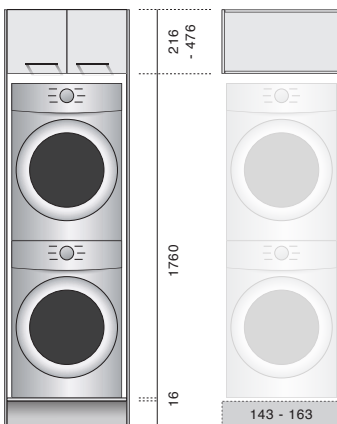

W: 682 (650 internal)  
D: 702

	KICKER HEIGHT	WASHER/ DRYER SPACE HEIGHT	OVERHEAD HEIGHT	OVERHEAD STORAGE OPTIONS		
				OPEN BOX	OPEN SHELF	2 DOOR OVERHEAD
2155	163	1760	216	•	-	-
	150		229	•	-	-
	147		232	•	-	-
	143		236	•	-	-
2275	163	1760	336	•	-	•
	150		349	•	-	•
	147		352	•	-	•
	143		352	•	-	•
2395	163	1760	456	•	-	•
	150		469	•	-	•
	147		472	•	-	•
	143		476	•	-	•





# Product Availability Guide (Matrix)

DESCRIPTION		CABINET DEPTHS (including door)				CABINET HEIGHTS (excluding kickboard height except TALL CABINETS which include a kickboard therefore is the overall cabinet height)									
		340	480	580	702	275	335	395	550	670	722	790	2155	2275	2395
<b>BASE</b>	<b>BASE DOOR</b>														
	BASE DOOR - 1 Door			•											
	BASE DOOR - 2 Door			•											
	<b>BASE RETURN</b>														
	BASE RETURN - 1 Door — 580 Deep (650 panel)			•											
	BASE RETURN - 2 Door — 580 Deep (650 panel)			•											
	<b>BASE OPEN SHELF</b>														
BASE OPEN SHELF - Unit			•												
BASE OPEN SHELF - Cube			•												
<b>OVERHEAD</b>	<b>OVERHEAD DOOR</b>														
	OVERHEAD DOOR - 1 Door	•	•												
	OVERHEAD DOOR - 2 Door	•	•												
	OVERHEAD DOOR - Lift Up Door	•	•												
	<b>OVERHEAD RETURN</b>														
	OVERHEAD RETURN - 1 Door — 340 Deep (410 panel)	•	•												
	OVERHEAD RETURN - 2 Door — 340 Deep (410 panel)	•	•												
	OVERHEAD RETURN - 1 Door — 480 Deep (550 panel)	•	•												
	OVERHEAD RETURN - 2 Door — 480 Deep (550 panel)	•	•												
	<b>OVERHEAD DOOR WITH HANGING RAIL UNDER</b>														
	OVERHEAD DOOR HR - 1 Door — (100mm drop down door, with hanging rail under)	•	•												
	OVERHEAD DOOR HR - 2 Door — (100mm drop down door, with hanging rail under)	•	•												
	OVERHEAD DOOR HR - Lift Up Door — (100mm drop down door, with hanging rail under)	•	•												
	<b>OVERHEAD OPEN SHELF</b>														
	OVERHEAD OPEN SHELF - Unit	•	•												
	OVERHEAD OPEN SHELF - Cube	•	•												
	<b>FLOATING SHELVING</b>														
MELAMINE WALL SHELF (Open Under) 16mm with 80mm high front rail <sup>1</sup>						150-600									
MELAMINE WALL SHELF (Open Under) 16mm with 80mm high front rail and hanging rail under <sup>1</sup>						340-600									
<b>TALL</b>	<b>TALL DOOR</b>														
	TALL DOOR - LINEN 1 Door			•											
	TALL DOOR - LINEN 2 Door			•											
	TALL DOOR - BROOM 1 Door			•											
	<b>TALL APPLIANCE TOWER - WASHER OR DRYER SPACE</b>														
	TALL APPLIANCE TOWER - Base 2 Door, Overhead 2 Door				•										
	TALL APPLIANCE TOWER - Base 2 Door, Overhead Open Shelf				•										
	TALL APPLIANCE TOWER - Base 2 Door, Overhead Open Box				•										
	TALL APPLIANCE TOWER - Base 2 Door with 1 Drawer (540,180), Overhead 2 Door				•										
	TALL APPLIANCE TOWER - Base 2 Door with 1 Drawer (540,180), Overhead Open Shelf				•										
	TALL APPLIANCE TOWER - Base 2 Door with 1 Drawer (540,180), Overhead Open Box				•										
	TALL APPLIANCE TOWER - Base 2 Drawer, Overhead 2 Door				•										
	TALL APPLIANCE TOWER - Base 2 Drawer, Overhead Open Shelf				•										
	TALL APPLIANCE TOWER - Base 2 Drawer, Overhead Open Box				•										
	<b>TALL APPLIANCE TOWER - WASHER &amp; DRYER STACK ON FLOOR</b>														
	TALL APPLIANCE TOWER - Overhead 2 Door				•										
	TALL APPLIANCE TOWER - Overhead Open Shelf				•										
	TALL APPLIANCE TOWER - Overhead Open Box				•										
	<b>TALL APPLIANCE TOWER - WASHER &amp; DRYER STACK IN CABINET</b>														
	TALL APPLIANCE TOWER - Overhead 2 Door and Kicker Base				•										
	TALL APPLIANCE TOWER - Overhead Open Box and Kicker Base				•										
	<b>TALL OPEN SHELF</b>														
	TALL OPEN SHELF - Unit — 5 Shelves			•											

<sup>1</sup> Please refer to LAUNDRY Catalogue on page 28 for details.



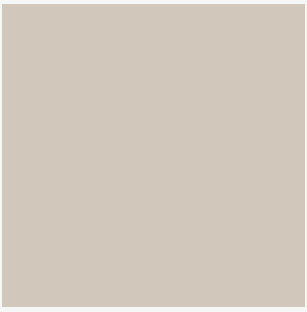



# VANITY

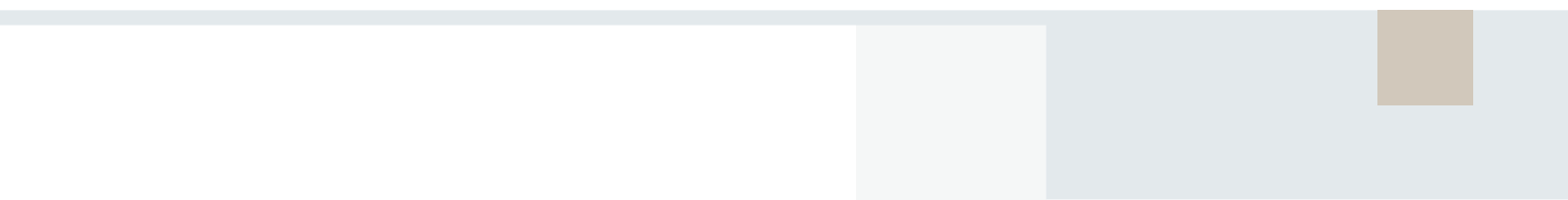

# Cabinet Library

## BASE DOOR

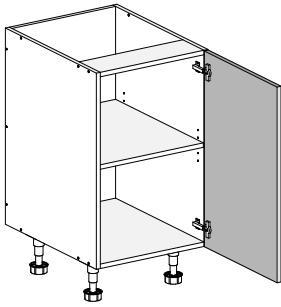

### 1 DOOR

H 400, 500, 600, 700  
W 250 - 600  
D 340, 480, 540

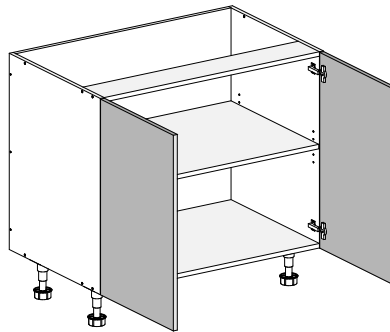

### 2 DOOR

H 400, 500, 600, 700  
W 600 - 1200  
D 340, 480, 540

## BASE DRAWER (HANDLES)

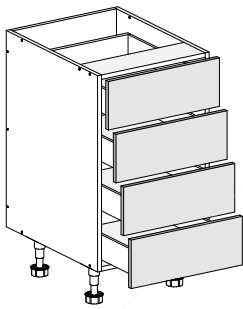

### 4 EQUAL DRAWER

H 700  
W 250 - 1200  
D 340, 480, 540

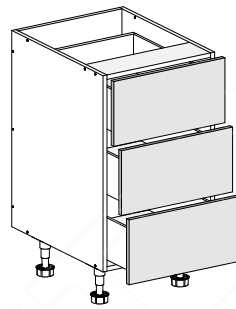

### 3 EQUAL DRAWER

H 500, 600, 700  
W 250 - 1200  
D 340, 480, 540

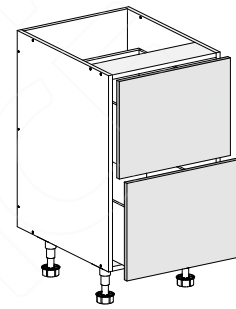

### 2 EQUAL DRAWER

H 400, 500, 600, 700  
W 250 - 1200  
D 340, 480, 540

## BASE DRAWER (HANDLE-LESS)

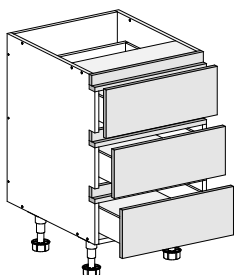

### 3 EQUAL DRAWER

H 600, 700  
W 250 - 1200  
D 340, 480, 540

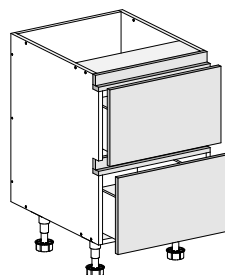

### 2 EQUAL DRAWER

H 400, 500, 600, 700  
W 250 - 1200  
D 340, 480, 540

### Design Note:

Base cabinet heights do not include kickboard.

## BASE OPEN SHELF

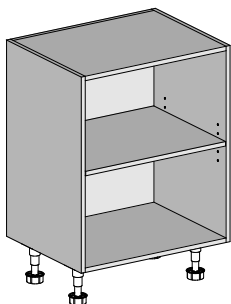

### SHELF UNIT

H 400, 500, 600, 700  
W 300 - 1000  
D 340, 480, 540

#### Features

- Adjustable shelf

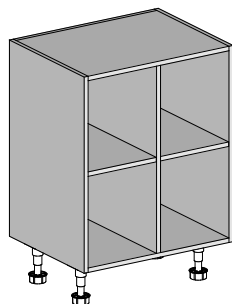

### CUBE

H 400, 500, 600, 700  
W 600 - 1200  
D 340, 480, 540

#### Features

- Fixed shelf

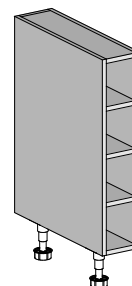

### TOWEL SHELF UNIT

H 400, 500, 600, 700  
W 150  
D 340, 480, 540

#### Features

- Fixed shelf

#### **Design Note:**

Base cabinet heights do not include kickboard.

## TALL MINI STORAGE

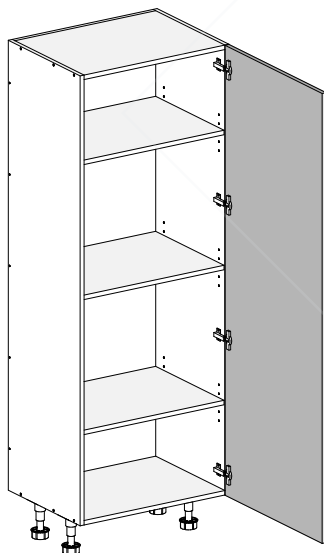

### 1 DOOR

H 1605  
W 300 - 600  
D 340, 480

#### Features

- Adjustable shelves

#### **Design Note:**

Tall Mini Storage cabinet height includes kickboard.

# Cabinet Library

## SHAVING CABINETS

There are two types of shaving cabinets in the Lifestyle range. The Melamine and Mirrored Door cabinets are made to the same specifications. See overleaf for details on Wall Mounted and In Cavity installation types.

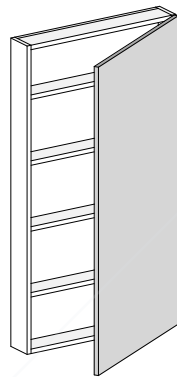

**1 DOOR - MELAMINE**

H 800, 900, 1000, 1200  
 W 400 - 600  
 D 100, 150

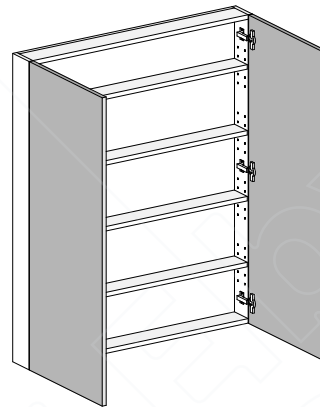

**2 DOOR - MELAMINE**

H 800, 900, 1000, 1200  
 W 600 - 1200  
 D 100, 150

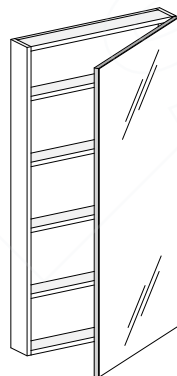

**1 DOOR - MIRROR**

H 800, 900, 1000, 1200  
 W 400 - 600  
 D 100, 150

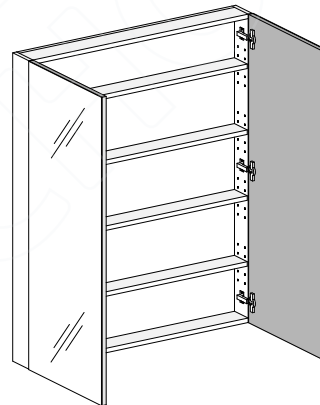

**2 DOOR - MIRROR**

H 800, 900, 1000, 1200  
 W 600 - 1200  
 D 100, 150



### 100 CABINET - Wall Mounted

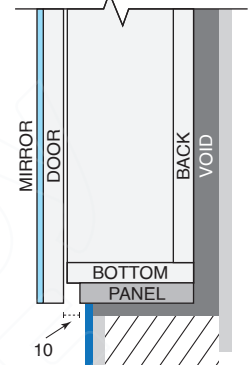
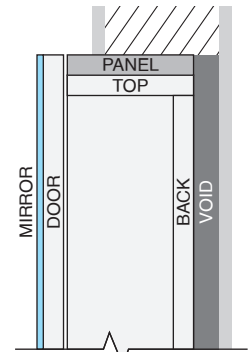
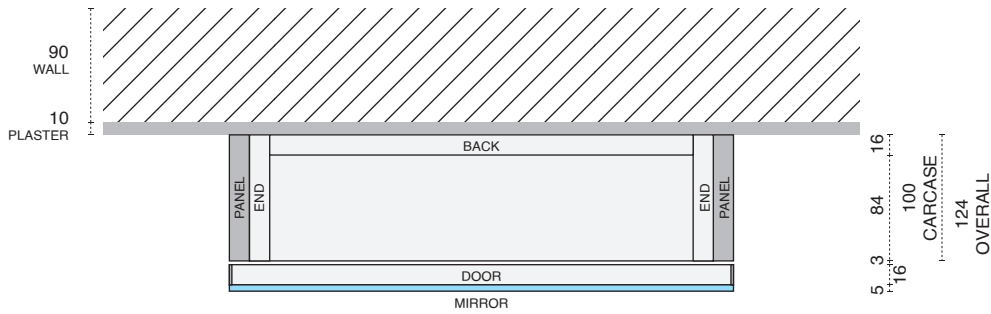

### 100 CABINET - In Cavity with Tiles (Narrow)

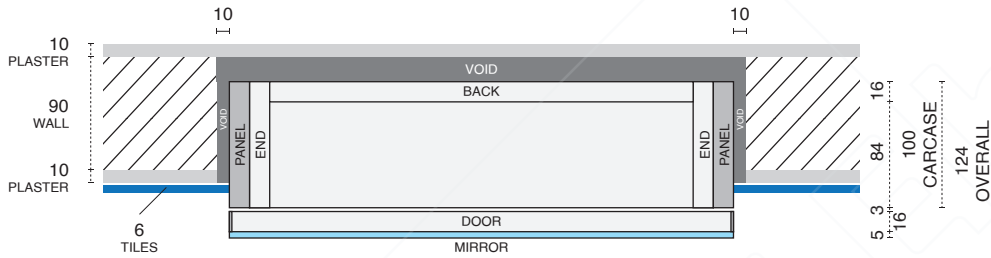

VOID WIDTH = DOOR WIDTH + 20mm  
 VOID WIDTH = DOOR HEIGHT + 10mm

IN CAVITY (NARROW)  
 SIDE VIEW

### 150 CABINET - In Cavity with Tiles (Deep)

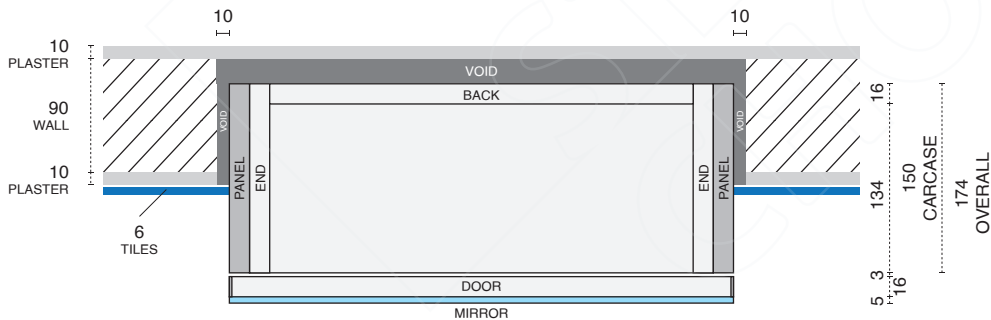

VOID WIDTH = DOOR WIDTH + 20mm  
 VOID WIDTH = DOOR HEIGHT + 10mm

### 150 CABINET - In Cavity (Deep)

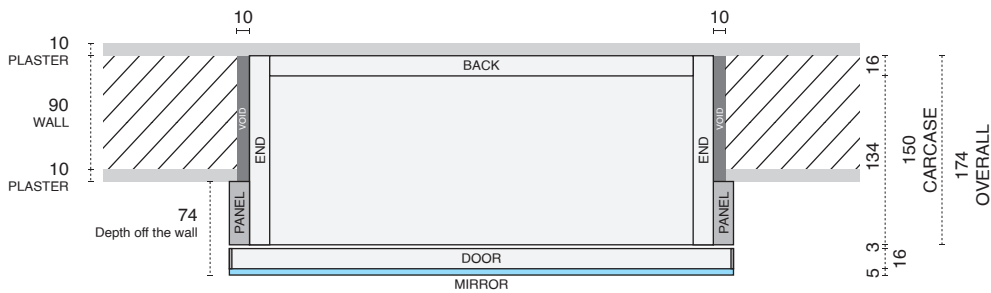

VOID WIDTH = DOOR WIDTH - 12mm  
 VOID WIDTH = DOOR HEIGHT - 6mm

# Product Availability Guide (Matrix)

DESCRIPTION	CABINET DEPTHS (including door)					CABINET HEIGHTS (excluding kickboard height except TALL CABINETS which include a kickboard therefore is the overall cabinet height)											CABINET WIDTH  <i>NOTE : Minimum 600mm wide cabinet is required to accommodate most single basins.</i>																							
	100	150	340	480	540	400	500	600	700	800	900	1000	1200	1605	150	200	250	300	350	400	450	500	550	600	650	700	750	800	850	900	950	1000	1050	1100	1150	1200				
<b>BASE DOOR</b>																																								
BASE DOOR - 1 Door																																								
BASE DOOR - 2 Door																																								
<b>BASE DRAWER (with handles)</b>																																								
BASE DRAWER - 2 Drawer																																								
BASE DRAWER - 3 Drawer																																								
BASE DRAWER - 4 Drawer																																								
<b>BASE DRAWER (handle-less)</b>																																								
BASE DRAWER - 2 Drawer																																								
BASE DRAWER - 3 Drawer																																								
<b>BASE OPEN SHELF</b>																																								
BASE OPEN SHELF - Unit																																								
BASE OPEN SHELF - Cube																																								
BASE TOWEL SHELF - Unit																																								
<b>TALL MINI STORAGE</b>																																								
TALL MINI - 1 DOOR																																								
<b>SHAVING CABINET - Melamine Door</b>																																								
SHAVING CABINET - 1 Door — Melamine																																								
SHAVING CABINET - 2 Door — Melamine																																								
<b>SHAVING CABINET - Mirror Door</b>																																								
SHAVING CABINET - 1 Door — Mirror																																								
SHAVING CABINET - 2 Door — Mirror																																								





Document Version 2.01

SbyC20210622